

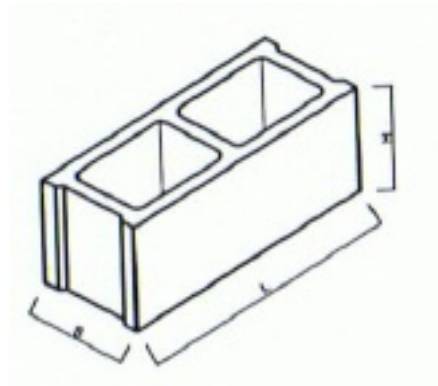

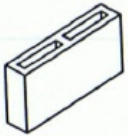

A. Zambetti Srl
manufatti in cemento

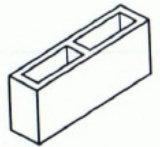
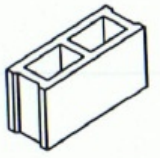
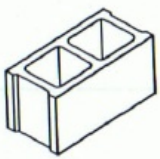
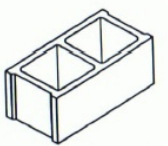

| BLOCCHI DA INTONACO | | | | | | | | | | | |
|---|--------|--------|--------------|------------------|-----|-----|-----|----|-------|-----------------|------------|
| Immagine | Codice | Tipo | Misura cm | Dimensioni mm | | | EI* | EI | MPa | N. per pacco | Peso Kg |
| | | | | S | H | L | | | | | |
| Lunghezza cm. 40 | | | | | | | | | | | |
|  | BI0840 | Forato | 8x20x40 | 75 | 195 | 395 | | | > 3,5 | 142 | 10 |
|  | BI1240 | Forato | 12x20x40 | 115 | 195 | 395 | | | > 3,5 | 123 | 13 |
|  | BI1540 | Forato | 15x20x40 | 145 | 195 | 395 | 30 | | > 3,5 | 95 | 14 |
|  | BI2040 | Forato | 20x20x40 | 195 | 195 | 395 | 90 | | > 3,5 | 75 | 17 |
|  | BI2540 | Forato | 25x20x40 | 245 | 195 | 395 | 120 | | | 56 | 22 |

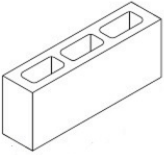
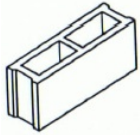
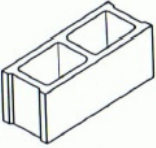
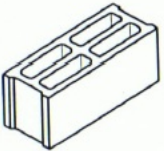
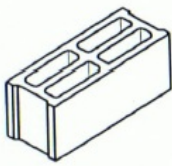

A. Zambetti Srl
manufatti in cemento

| Lunghezza cm. 50 | | | | | | | | | | | |
|---|--------|-------------|----------|-----|-----|-----|-----|--|-------|-----|------|
|  | BI0850 | Forato | 8x20x50 | 75 | 195 | 495 | | | > 3,5 | 120 | 11 |
|  | BI1256 | Forato | 12x20x50 | 115 | 195 | 495 | 120 | | > 3,5 | 80 | 17,5 |
|  | BI1550 | Forato | 15x20x50 | 145 | 195 | 495 | 60 | | > 3,5 | 72 | 17 |
|  | BI2050 | Forato | 20x20x50 | 195 | 195 | 495 | 120 | | > 3,5 | 60 | 20 |
|  | BI2060 | Multicamera | 20x20x50 | 195 | 195 | 495 | 120 | | > 3,5 | 60 | 22 |
|  | BI2560 | Multicamera | 25x20x50 | 245 | 195 | 495 | 180 | | > 3,5 | 48 | 22 |

I blocchi possono essere forniti anche CON ARGILLA e/o colorati e/o impermeabilizzati

EI* = Classificazione tabellare D.M. 16/2/2007 punto D.4.2
EI = Certificato di resistenza al fuoco
MPa = Resistenza media a compressione



A. Zambetti Srl
manufatti in cemento

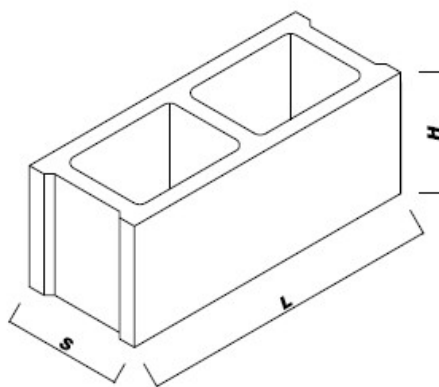

BLOCCHI FACCIA VISTA

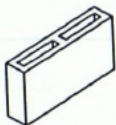
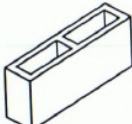
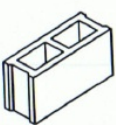
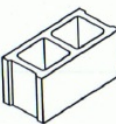
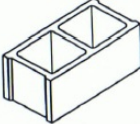
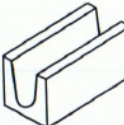
| Immagine | Codice | Tipo | Misura cm | Dimensioni mm | | | EI* | EI | MPa | N. per pacco | Peso Kg |
|---|--------|--------|-----------|---------------|-----|-----|-----|----|-------|--------------|---------|
| | | | | S | H | L | | | | | |
| Lunghezza cm. 40 | | | | | | | | | | | |
|  | BP1200 | Forato | 8x20x40 | 75 | 195 | 395 | | | > 3,5 | 142 | 10 |
|  | BP1210 | Forato | 12x20x40 | 115 | 195 | 395 | | | > 3,5 | 123 | 13 |
|  | BP1220 | Forato | 15x20x40 | 145 | 195 | 395 | 30 | | > 3,5 | 95 | 14 |
|  | BP1230 | Forato | 20x20x40 | 195 | 195 | 395 | 90 | | > 3,5 | 75 | 17 |
|  | BP1240 | Forato | 25x20x40 | 245 | 195 | 395 | 120 | | | 56 | 22 |
|  | BP1500 | Correa | 20x20x40 | 195 | 195 | 395 | | | | 60 | 14 |



A. Zambetti Srl
manufatti in cemento

Lunghezza cm. 50

| | | | | | | | | | | | |
|--|--------|-------------|----------|-----|-----|-----|-----|-----|-------|-----|------|
| | BP1205 | Forato | 8x20x50 | 75 | 195 | 495 | | | > 3,5 | 120 | 11 |
| | BP1219 | Forato | 12x20x50 | 115 | 195 | 495 | | 120 | > 3,5 | 80 | 17,5 |
| | BP1250 | Forato | 15x20x50 | 145 | 195 | 495 | | 60 | > 3,5 | 72 | 17 |
| | BP1260 | Forato | 20x20x50 | 195 | 195 | 495 | | 120 | > 3,5 | 60 | 20 |
| | BP1270 | Multicamera | 20x20x50 | 195 | 195 | 495 | 120 | | > 3,5 | 60 | 22 |
| | BF2560 | Multicamera | 25x20x50 | 245 | 195 | 495 | 180 | | > 3,5 | 48 | 22 |
| | BP1510 | Correa | 20x20x50 | 195 | 195 | 495 | | | | 60 | 25 |
| | BP1520 | Correa | 25x20x50 | 245 | 195 | 495 | | | | 40 | 25 |

I blocchi possono essere forniti anche **CON ARGILLA e/o colorati e/o impermeabilizzati**

EI* = Classificazione tabellare D.M. 16/2/2007 punto D.4.2

EI = Certificato di resistenza al fuoco



MPa = Resistenza media a compressione

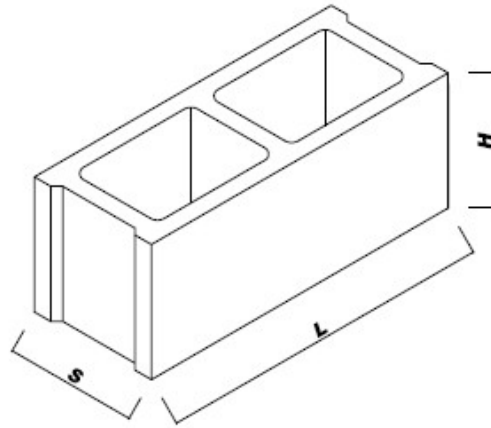

A. Zambetti Srl
manufatti in cemento

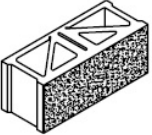

BLOCCHI FACCIA VISTA SPECIALI

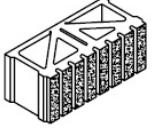
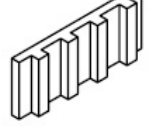
| Immagine | Codice | Tipo | Misura cm | Dimensioni mm | | | EI* | EI | MPa | N. per pacco | Peso Kg |
|---|---------|------------|-----------|---------------|-----|-----|-----|----|-----|--------------|---------|
| | | | | S | H | L | | | | | |
|  | BPS7550 | Splittato | 20x20x50 | 195 | 195 | 495 | | | | 48 | 26 |
|  | BFC1550 | Cannellato | 15x20x50 | 145 | 195 | 495 | | | | 60 | 20 |
|  | BFC1560 | Cannellato | 20x20x50 | 220 | 195 | 495 | | | | 48 | 28 |
|  | AL1950 | Tavella | 6x20x50 | 595 | 195 | 495 | | | | 140 | 10 |

I blocchi possono essere forniti anche **CON ARGILLA** e/o colorati e/o impermeabilizzati

EI* = Classificazione tabellare D.M. 16/2/2007 punto D.4.2

EI = Certificato di resistenza al fuoco

MPa = Resistenza media a compressione

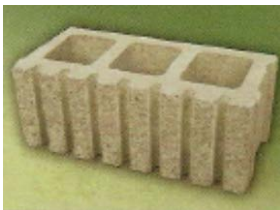



A. Zambetti Srl
manufatti in cemento

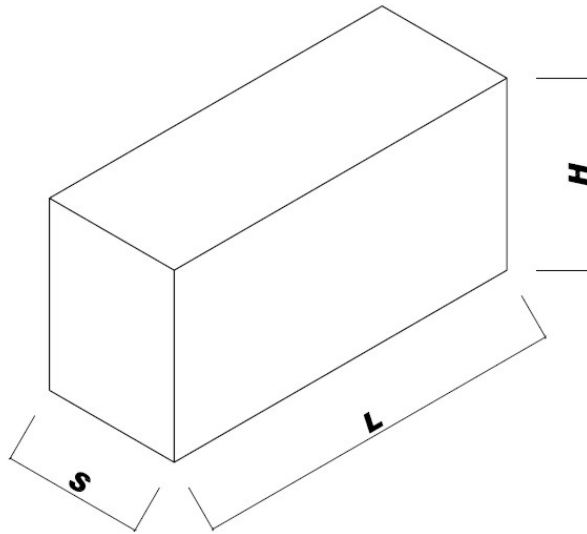

BLOCCHI PIENI

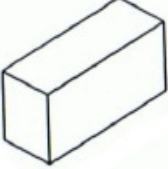
| Immagine | Codice | Tipo | Misura cm | Dimensioni mm | | | EI* | EI | MPa | N. per pacco | Peso Kg |
|---|--------|---------|-----------|---------------|-----|-----|-----|----|-------|--------------|---------|
| | | | | S | H | L | | | | | |
|  | BP1300 | Mattone | 6x12x24 | 60 | 120 | 240 | | | | 320 | 4 |
|  | BP1100 | Pieno | 15x20x40 | 145 | 195 | 395 | 60 | | > 3,5 | 57 | 25 |

I blocchi possono essere forniti anche **CON ARGILLA** e/o colorati e/o impermeabilizzati

EI* = Classificazione tabellare D.M. 16/2/2007 punto D.4.2

EI = Certificato di resistenza al fuoco



MPa = Resistenza media a compressione



A. Zambetti Srl
manufatti in cemento

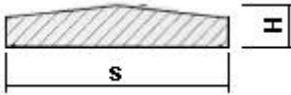
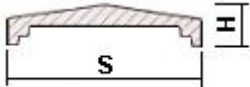

COPERTINE

| Codice | Tipo | Misura cm | Dimensioni mm | | | Spessore muro cm | Peso Kg |
|--------|---|--------------|------------------|----|------|---------------------|------------|
| | | | S | H | L | | |
| BC3060 | Vibropressato | 30x6x100 | 300 | 60 | 1000 | 20 | 37 |
| BC3660 |  | 36x6x100 | 360 | 60 | 1000 | 25 | 46 |
| BC2575 | Vibrogettato | 25x6x100 | 250 | 60 | 1000 | 15 | 22 |
| BC3075 |  | 30x6x100 | 300 | 60 | 1000 | 20 | 25 |
| BC3580 |  | 35x6x100 | 350 | 60 | 1000 | 25 | 32 |





A. Zambetti Srl
manufatti in cemento



BLOCCHI PER MURI A SECCO

| Codice | Tipo | Lunghezza cm | Larghezza cm | Altezza cm | Spessore cm | Peso Kg |
|--------|----------|-----------------|-----------------|---------------|----------------|------------|
| AL1900 | 36x50x20 | 50 | 36 | 20 | 6 | 35 |