

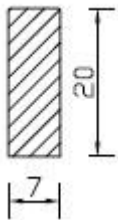



**A. Zambetti Srl**  
manufatti in cemento

### CORDOLI VIBROPRESSATI

| Codice | Tipo     | Dimensioni cm   | Lunghezza cm | Elemento a "bocca di lupo" | Curve raggio cm | Pezzi per ¼ di cerchio | Maschiatura | Peso Kg/ml |     |     |   |
|--------|----------|---|--------------|----------------------------|-----------------|------------------------|-------------|------------|-----|-----|---|
| AM1270 | 7x20     |    | 100          |                            |                 |                        | si          | 32         |     |     |   |
| AM1260 | 7x25     |   | 100          |                            |                 |                        | si          | 40         |     |     |   |
| AM1261 |          |   |              |                            |                 |                        |             |            |     | 25  | 1 |
|        |          |   |              |                            |                 |                        |             |            |     | 50  | 1 |
|        |          |   | 100          | 2                          |                 |                        |             |            |     |     |   |
| AM1250 | 10x25    |  | 100          |                            |                 |                        | no          | 60         |     |     |   |
| AM1253 |          |   | 50           |                            |                 |                        |             |            |     |     |   |
|        |          |   |              |                            |                 |                        |             |            | 25  | 1   |   |
|        |          |   |              |                            |                 |                        |             |            | 50  | 1   |   |
|        |          |   |              |                            |                 |                        |             |            | 100 | 2   |   |
|        |          |   |              |                            |                 |                        |             |            | 200 | 4   |   |
|        |          |   |              |                            |                 |                        |             |            | 300 | 5   |   |
|        |          |   |              |                            |                 |                        |             |            | 400 | 7   |   |
|        |          | 500   | 10           |                            |                 |                        |             |            |     |     |   |
|        |          | 600   | 12           |                            |                 |                        |             |            |     |     |   |
| AM1240 | 12x25    |  | 100          |                            |                 |                        | no          | 70         |     |     |   |
| AM1241 |          |   |              |                            |                 |                        |             |            |     | 50  | 1 |
|        |          |   |              |                            |                 |                        |             |            |     | 100 | 2 |
|        |          |   |              |                            |                 |                        |             |            |     | 200 | 4 |
|        |          | 300   | 5            |                            |                 |                        |             |            |     |     |   |
| AM1200 | 12/15x25 |  | 100          | Si                         |                 |                        | no          | 80         |     |     |   |
| AM1203 |          |   | 50           |                            |                 |                        |             |            |     |     |   |
| AM1202 |          |   | 100          |                            |                 |                        |             |            |     |     |   |
|        |          |   |              |                            |                 |                        |             |            | 25  | 1   |   |
|        |          |   |              |                            |                 |                        |             |            | 50  | 1   |   |
|        |          |   |              |                            |                 |                        |             |            | 100 | 2   |   |
|        |          |   |              |                            |                 |                        |             |            | 200 | 4   |   |
|        |          | 300   | 5            |                            |                 |                        |             |            |     |     |   |
|        |          | 400   | 6            |                            |                 |                        |             |            |     |     |   |
|        |          | 500   | 10           |                            |                 |                        |             |            |     |     |   |
|        |          | 600   | 12           |                            |                 |                        |             |            |     |     |   |

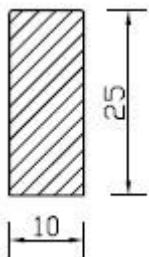
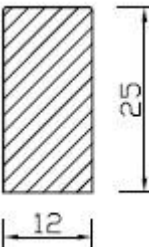
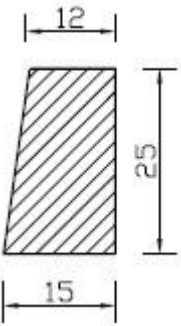

# A. Zambetti Srl

manufatti in cemento

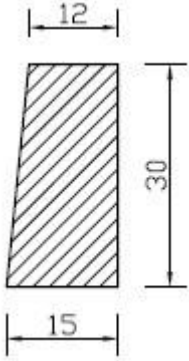
| Codice   | Tipo     | Dimensioni cm   | Lunghezza cm | Elemento a "bocca di lupo" | Curve raggio cm | Pezzi per ¼ di cerchio | Maschiatura | Peso Kg/ml |
|--|----------|---|--------------|----------------------------|-----------------|------------------------|-------------|------------|
| AM1230   | 12/15x30 |  | 100          |                            |                 |                        | no          | 95         |
| Classe di resistenza $S \geq 3,50$ MPa   |          |   |              |                            |                 |                        |             |            |
| Tutti i tipi possono essere prodotti in cemento bianco o colorato su ordinazione |          |   |              |                            |                 |                        |             |            |





**A. Zambetti Srl**  
manufatti in cemento

## CORDOLI VIBROGETTATI

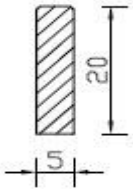
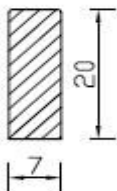
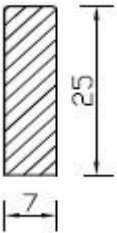
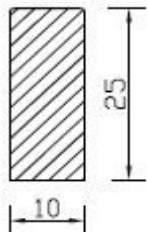
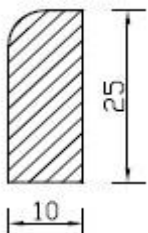
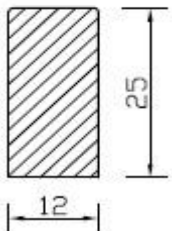
| Codice | Tipo              | Dimensioni cm   | Lunghezza cm | Elemento a "bocca di lupo" | Curve raggio cm | Pezzi per ¼ di cerchio | Maschiatura | Peso Kg/ml |
|--------|-------------------|---|--------------|----------------------------|-----------------|------------------------|-------------|------------|
| AM1500 | 5x20              |    | 150          |                            |                 |                        | no          | 35         |
| AM1300 | 7x20              |    | 100          |                            |                 |                        | no          | 32         |
| AM1303 |                   |   | 50           |                            |                 |                        |             |            |
| AM1302 |                   |   | 100          | si                         |                 |                        |             |            |
| AM1301 |                   |   |              |                            | 50              | 1                      |             |            |
| AM1310 | 7x25              |   | 100          |                            |                 |                        | no          | 40         |
| AM1313 |                   |   | 50           |                            |                 |                        |             |            |
| AM1312 |                   |   | 100          | si                         |                 |                        |             |            |
| AM1311 |                   |   |              |                            | 50              | 1                      |             |            |
| AM1320 | 10x25             |  | 100          |                            |                 |                        | si          | 60         |
| AM1323 |                   |   | 50           |                            |                 |                        |             |            |
| AM1322 |                   |   | 100          | si                         |                 |                        |             |            |
| AM1321 |                   |   |              |                            | 50              | 1                      |             |            |
| AM1400 | 10x25 arrotondato |  | 100          |                            |                 |                        | si          | 55         |
| AM1403 |                   |   | 50           |                            |                 |                        |             |            |
| AM1402 |                   |   | 100          | si                         |                 |                        |             |            |
| AM1401 |                   |   |              |                            | 50              | 1                      |             |            |
| AM1330 | 12x25             |  | 100          |                            |                 |                        | si          | 70         |
| AM1333 |                   |   | 50           |                            |                 |                        |             |            |
| AM1332 |                   |   | 100          | si                         |                 |                        |             |            |
| AM1331 |                   |   |              |                            | 50              | 1                      |             |            |



# A. Zambetti Srl

manufatti in cemento



| Codice   | Tipo              | Dimensioni cm | Lunghezza cm | Elemento a "bocca di lupo" | Curve raggio cm | Pezzi per ¼ di cerchio | Maschiatura | Peso Kg/ml |
|--|-------------------|---------------|--------------|----------------------------|-----------------|------------------------|-------------|------------|
| AM1340   | 12x30             |               | 100          |                            |                 |                        | si          | 85         |
| AM1343   |                   |               | 50           |                            |                 |                        |             |            |
| AM1342   |                   |               | 100          | si                         |                 |                        |             |            |
| AM1341   |                   |               |              |                            | 50              | 1                      |             |            |
| AM1410   | 12x30 arrotondato |               | 100          |                            |                 |                        | si          | 120        |
| AM1413   |                   |               | 50           |                            |                 |                        |             |            |
| AM1412   |                   |               | 100          | si                         |                 |                        |             |            |
| AM1120   | 12/15x25          |               | 100          |                            |                 |                        | si          | 80         |
| AM1123   |                   |               | 50           |                            |                 |                        |             |            |
| AM1122   |                   |               | 100          | si                         |                 |                        |             |            |
| AM1121   |                   |               |              |                            | 50              | 1                      |             |            |
| AM1100   | 15/18x30          |               | 100          |                            |                 |                        | si          | 115        |
| AM1103   |                   |               | 50           |                            |                 |                        |             |            |
| AM1102   |                   |               | 100          | si                         |                 |                        |             |            |
| AM1101   |                   |               |              |                            | 50              | 1                      |             |            |
| Tutti i tipi possono essere prodotti in cemento bianco o colorato su ordinazione |                   |               |              |                            |                 |                        |             |            |

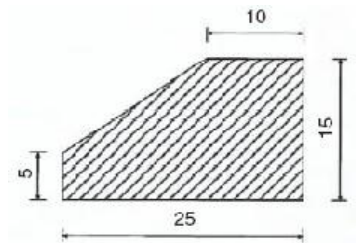

**A. Zambetti Srl**  
manufatti in cemento

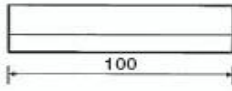
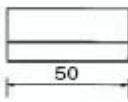

### CORDOLI SPARTITRAFFICO TIPO BERGAMO

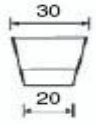
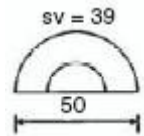
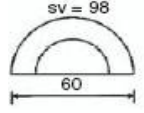
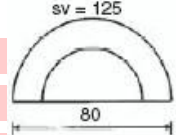
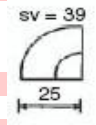
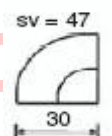
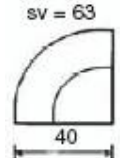
| CODICE | TIPO                           | Lunghezza<br>cm  | Raggio minimo<br>cm | Peso<br>Kg |
|--------|--------------------------------|--|---------------------|------------|
| AM2100 | <b>Cordolo 10/25x5/15hx100</b> |    |                     | 66         |
| AM2110 | <b>Cordolo 10/25x5/15hx50</b>  |    |                     | 33         |
| AM2120 | <b>Settore per curve 10/20</b> |     | 50                  | 10         |
| AM2121 | <b>Settore per curve 20/30</b> |   | 85                  | 18         |
| AM2130 | <b>Mezzo cerchio Ø 50</b>      |  |                     | 23         |
| AM2130 | <b>Mezzo cerchio Ø 60</b>      |  |                     | 35         |
| AM2130 | <b>Mezzo cerchio Ø 80</b>      |  |                     | 65         |
| AM2130 | <b>Quarto di cerchio Ø 50</b>  |  |                     | 11         |
| AM2130 | <b>Quarto di cerchio Ø 60</b>  |  |                     | 17         |
| AM2130 | <b>Quarto di cerchio Ø 80</b>  |  |                     | 32         |



**A. Zambetti Srl**  
manufatti in cemento

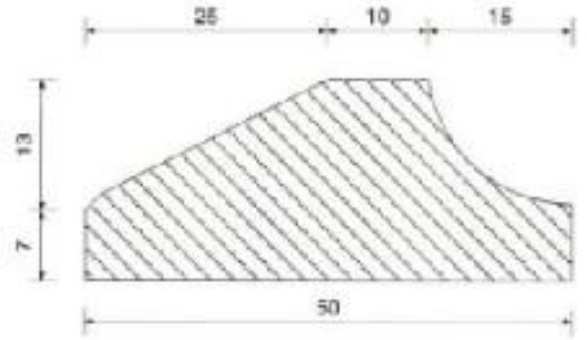

### CORDOLI SPARTITRAFFICO TIPO PROVINCIA BG

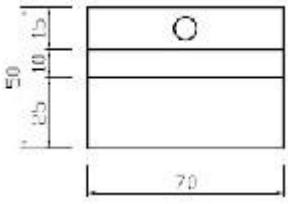
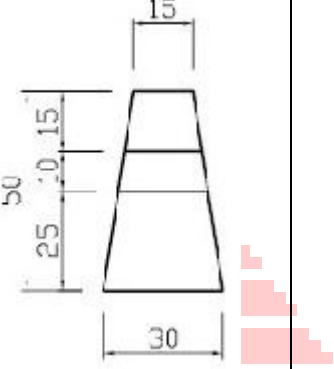
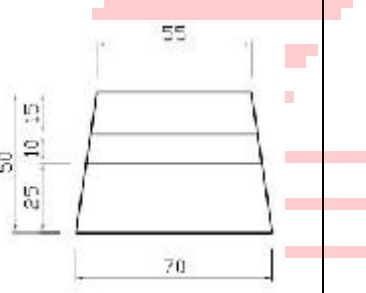
| CODICE | TIPO                           | Lunghezza cm   | Raggio minimo cm | Peso Kg |
|--------|--------------------------------|--|------------------|---------|
| AM3100 | <b>Cordolo 50x20hx70</b>       |   |                  | 119     |
| AM3110 | <b>Settore per curve 15/30</b> |  | 50               | 40      |
| AM3111 | <b>Settore per curve 55/70</b> |  | 85               | 100     |



**A. Zambetti Srl**  
manufatti in cemento

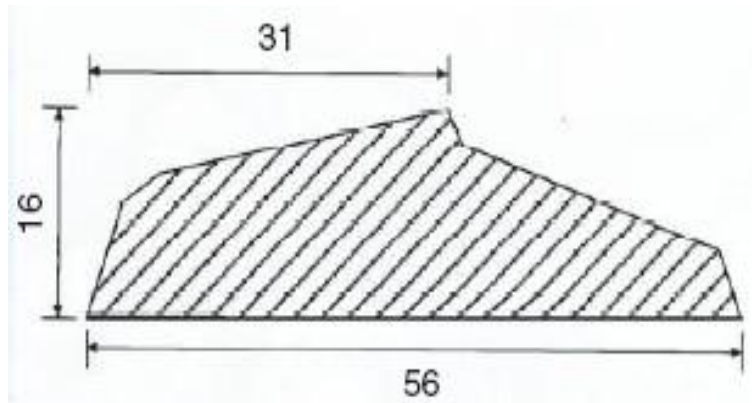

### CORDOLI SPARTITRAFFICO TIPO PROVINCIA MI

| CODICE | TIPO | Lunghezza<br>cm | Raggio<br>minimo<br>cm | Peso<br>Kg |
|--------|------|-----------------|------------------------|------------|
| AM3200 | A1   |                 | 400                    | 80         |
| AM3200 | B1   |                 | 340                    | 75         |
| AM3210 | A2   |                 | 220                    | 43         |

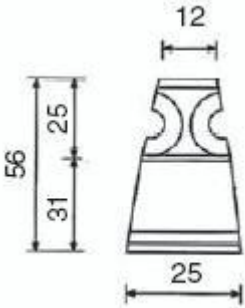
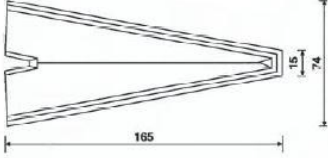
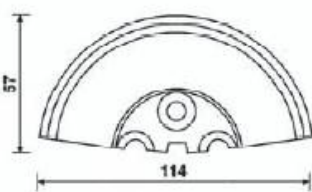
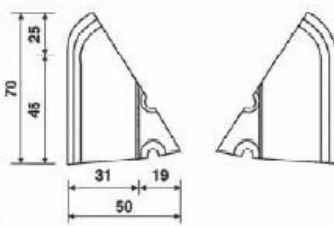
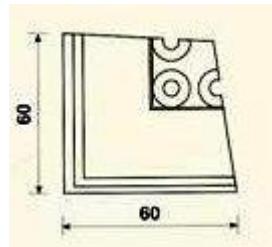

**A. Zambetti Srl**  
manufatti in cemento

| CODICE | TIPO                     | Lunghezza<br>cm  | Raggio<br>minimo<br>cm | Peso<br>Kg |
|--------|--------------------------|--|------------------------|------------|
| AM3210 | A3                       |    | 130                    | 26         |
| AM3220 | Punta                    |    |                        | 145        |
| AM3220 | Mezza circonferenza      |  |                        | 120        |
| AM3225 | Goccia destra o sinistra |  |                        | 45         |
| AM3230 | Angolo 90°               |  |                        | 60         |