

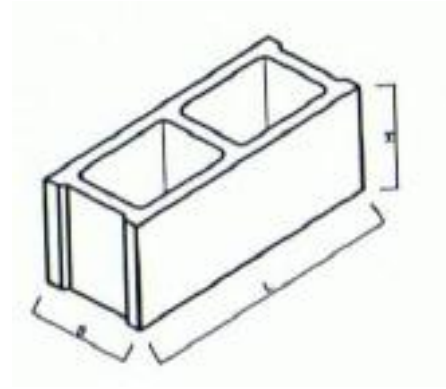



**A. Zambetti Srl**  
manufatti in cemento



BLOCCHI DA INTONACO											
Immagine	Codice	Tipo	Misura cm	Dimensioni mm			REI	EI	MPa	N. per pacco	Peso Kg
				S	H	L					
Lunghezza cm. 40											
	BI0840	Forato	8x20x40	75	195	395			> 3,5	142	10
	BI1240	Forato	12x20x40	115	195	395			> 3,5	123	13
	BI1540	Forato	15x20x40	145	195	395			> 3,5	95	14
	BI2040	Forato	20x20x40	195	195	395			> 3,5	75	17
	BI2540	Forato	25x20x40	245	195	395				56	22

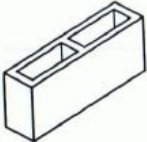
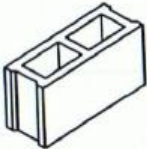
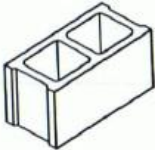
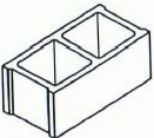

**A. Zambetti Srl**  
manufatti in cemento

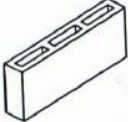
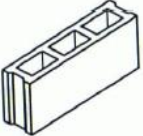
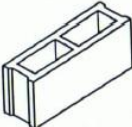
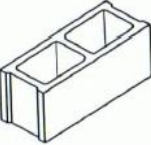
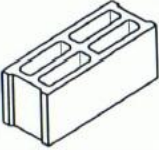
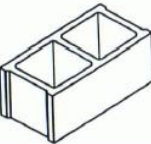
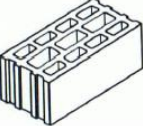
Lunghezza cm. 50											
	BI0850	Forato	8x20x50	75	195	495	45		> 3,5	120	11
	BI1250	Forato	12x20x50	115	195	495	60		> 3,5	96	14
	BI1255						90				
	BI1256							120			
	BI1550	Forato	15x20x50	145	195	495	60		> 3,5	72	17
	BI2050	Forato	20x20x50	195	195	495	120		> 3,5	60	20
	BI2060	Semiportante	20x20x50	195	195	495	180		> 3,5	60	22
	BI2550	Forato	25x20x50	245	195	495	120		> 3,5	48	25
	BI2560	Semiportante	25x20x50	245	195	495	120		> 3,5	48	29

I blocchi possono essere forniti anche colorati e/o impermeabilizzati

**REI/EI** = Certificato di resistenza al fuoco  
**MPa** = Resistenza media a compressione



**A. Zambetti Srl**  
manufatti in cemento

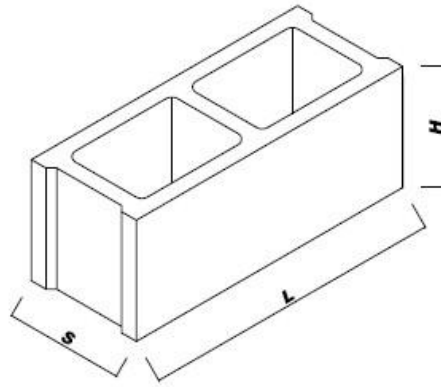

### BLOCCHI FACCIA VISTA

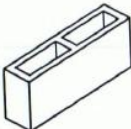
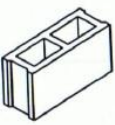
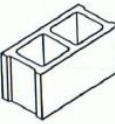
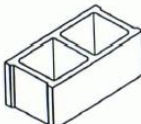
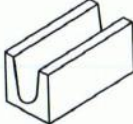
Immagine	Codice	Tipo	Misura cm	Dimensioni mm			REI	EI	MPa	N. per pacco	Peso Kg
				S	H	L					
<b>Lunghezza cm. 40</b>											
	BP1200	Forato	8x20x40	75	195	395			> 3,5	142	10
	BP1210	Forato	12x20x40	115	195	395			> 3,5	123	13
	BP1220	Forato	15x20x40	145	195	395			> 3,5	95	14
	BP1230	Forato	20x20x40	195	195	395			> 3,5	75	17
	BP1240	Forato	25x20x40	245	195	395				56	22
	BP1500	Correa	20x20x40	195	195	395				60	14

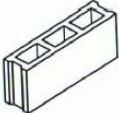
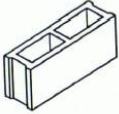
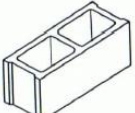
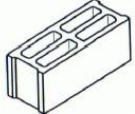
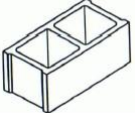
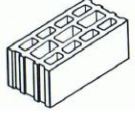
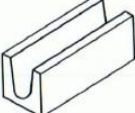
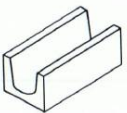

**A. Zambetti Srl**  
manufatti in cemento

Lunghezza cm. 50											
	BP1205	Forato	8x20x50	75	195	495	45		> 3,5	120	11
	BP1215	Forato	12x20x50	115	195	495	60		> 3,5	96	14
	BP1217						90		> 3,5	96	14
	BP1219							120	> 3,5	96	14
	BP1250	Forato	15x20x50	145	195	495	60		> 3,5	72	17
	BP1260	Forato	20x20x50	195	195	495	120		> 3,5	60	20
	BP1270	Semiportante	20x20x50	195	195	495	180		> 3,5	60	22
	BF2550	Forato	25x20x50	245	195	495	120		> 3,5	48	25
	BF2560	Semiportante	25x20x50	245	195	495	120		> 3,5	48	29
	BP1510	Correa	20x20x50	195	195	495				60	25
	BP1520	Correa	25x20x50	245	195	495				40	25

I blocchi possono essere forniti anche colorati e/o impermeabilizzati

**RE/EI** = Certificato di resistenza al fuoco



**MPa** = Resistenza media a compressione

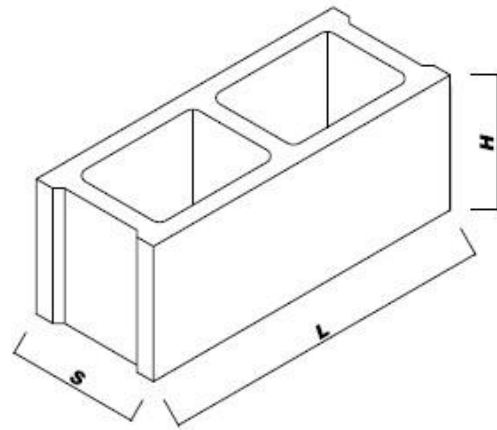

**A. Zambetti Srl**  
manufatti in cemento

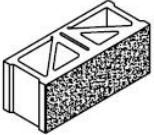

### BLOCCHI FACCIA VISTA SPECIALI

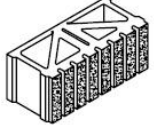
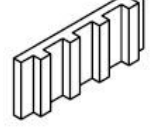
Immagine	Codice	Tipo	Misura cm	Dimensioni mm			REI	EI	MPa	N. per pacco	Peso Kg
				S	H	L					
	BPS7550	Splittato	20x20x50	195	195	495				48	26
	BFC1550	Cannellato	15x20x50	145	195	495				60	20
	BFC1560	Cannellato	20x20x50	220	195	495				48	28
	AL1950	Tavella	6x20x50	595	195	495				140	10

I blocchi possono essere forniti anche colorati e/o impermeabilizzati

**REI/EI** = Certificato di resistenza al fuoco  
**MPa** = Resistenza media a compressione





**A. Zambetti Srl**  
manufatti in cemento

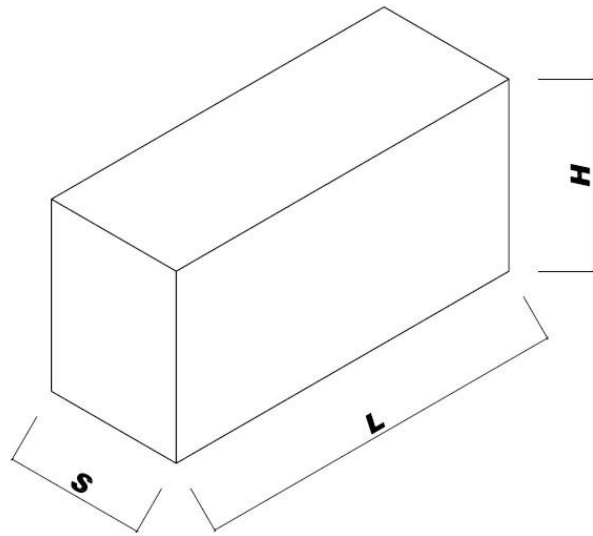

### BLOCCHI PIENI

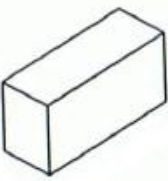
Immagine	Codice	Tipo	Misura cm	Dimensioni mm			REI	EI	MPa	N. per pacco	Peso Kg
				S	H	L					
	BP1300	Mattone	6x12x24	60	120	240				320	4
	BP1100	Pieno	15x20x40	145	195	395			> 3,5	57	25

I blocchi possono essere forniti anche colorati e/o impermeabilizzati

**REI/EI** = Certificato di resistenza al fuoco



**MPa** = Resistenza media a compressione



**A. Zambetti Srl**  
manufatti in cemento

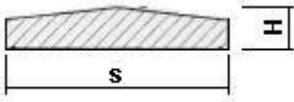
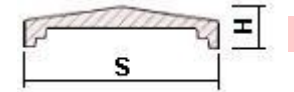

### COPERTINE

Codice	Tipo	Misura cm	Dimensioni mm			Spessore muro cm	Peso Kg
			S	H	L		
BC3060	Vibropressato	30x6x100	300	60	1000	20	37
BC3660		36x6x100	360	60	1000	25	46
BC2575	Vibrogettato	25x6x100	250	60	1000	15	22
BC3075		30x6x100	300	60	1000	20	25
BC3580		35x6x100	350	60	1000	25	32





**A. Zambetti Srl**  
manufatti in cemento



### BLOCCHI PER MURI A SECCO

Codice	Tipo	Lunghezza cm	Larghezza cm	Altezza cm	Spessore cm	Peso Kg
AL1900	36x50x20	50	36	20	6	35