

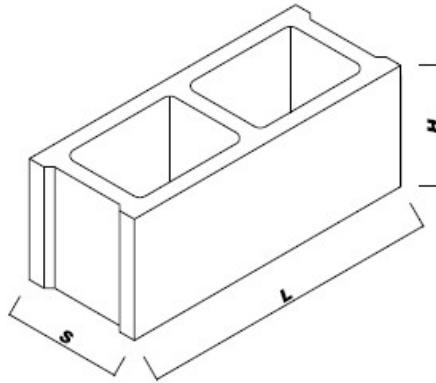

A. Zambetti Srl
manufatti in cemento

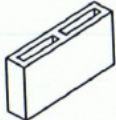
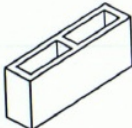
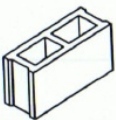
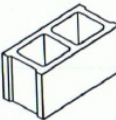
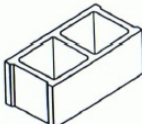
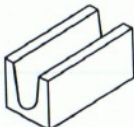

BLOCCHI FACCIA VISTA

Immagine	Codice	Tipo	Misura cm	Dimensioni mm			EI*	EI	MPa	N. per pacco	Peso Kg
				S	H	L					
Lunghezza cm. 40											
	BP1200	Forato	8x20x40	75	195	395			> 3,5	142	10
	BP1210	Forato	12x20x40	115	195	395			> 3,5	123	13
	BP1220	Forato	15x20x40	145	195	395	30		> 3,5	95	14
	BP1230	Forato	20x20x40	195	195	395	90		> 3,5	75	17
	BP1240	Forato	25x20x40	245	195	395	120			56	22
	BP1500	Correa	20x20x40	195	195	395				60	14



A. Zambetti Srl
manufatti in cemento

Lunghezza cm. 50

	BP1205	Forato	8x20x50	75	195	495			> 3,5	120	11
	BP1219	Forato	12x20x50	115	195	495		120	> 3,5	80	17,5
	BP1250	Forato	15x20x50	145	195	495		60	> 3,5	72	17
	BP1260	Forato	20x20x50	195	195	495		120	> 3,5	60	20
	BP1270	Multicamera	20x20x50	195	195	495	120		> 3,5	60	22
	BF2560	Multicamera	25x20x50	245	195	495	180		> 3,5	48	22
	BP1510	Correa	20x20x50	195	195	495				60	25
	BP1520	Correa	25x20x50	245	195	495				40	25

I blocchi possono essere forniti anche **CON ARGILLA e/o colorati e/o impermeabilizzati**

EI* = Classificazione tabellare D.M. 16/2/2007 punto D.4.2

EI = Certificato di resistenza al fuoco

MPa = Resistenza media a compressione