

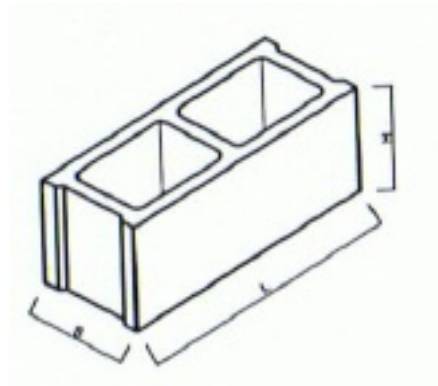

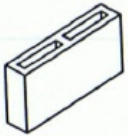

A. Zambetti Srl
manufatti in cemento

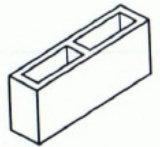
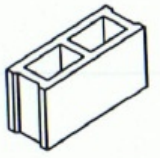
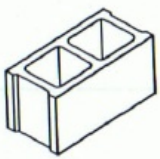
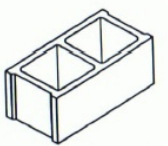

BLOCCHI DA INTONACO											
Immagine	Codice	Tipo	Misura cm	Dimensioni mm			EI*	EI	MPa	N. per pacco	Peso Kg
				S	H	L					
Lunghezza cm. 40											
	BI0840	Forato	8x20x40	75	195	395			> 3,5	142	10
	BI1240	Forato	12x20x40	115	195	395			> 3,5	123	13
	BI1540	Forato	15x20x40	145	195	395	30		> 3,5	95	14
	BI2040	Forato	20x20x40	195	195	395	90		> 3,5	75	17
	BI2540	Forato	25x20x40	245	195	395	120			56	22

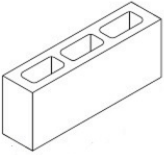
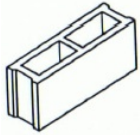
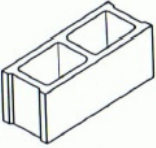
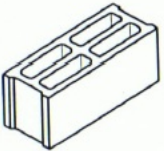
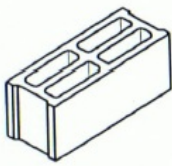

A. Zambetti Srl
manufatti in cemento

Lunghezza cm. 50											
	BI0850	Forato	8x20x50	75	195	495			> 3,5	120	11
	BI1256	Forato	12x20x50	115	195	495		120	> 3,5	80	17,5
	BI1550	Forato	15x20x50	145	195	495		60	> 3,5	72	17
	BI2050	Forato	20x20x50	195	195	495		120	> 3,5	60	20
	BI2060	Multicamera	20x20x50	195	195	495	120		> 3,5	60	22
	BI2560	Multicamera	25x20x50	245	195	495	180		> 3,5	48	22

I blocchi possono essere forniti anche CON ARGILLA e/o colorati e/o impermeabilizzati

EI* = Classificazione tabellare D.M. 16/2/2007 punto D.4.2
EI = Certificato di resistenza al fuoco
MPa = Resistenza media a compressione