

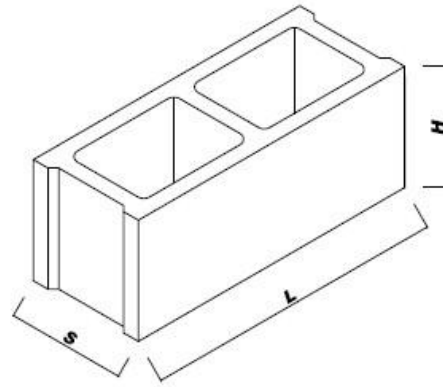





**A. Zambetti Srl**  
manufatti in cemento



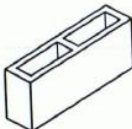

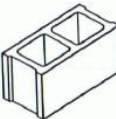
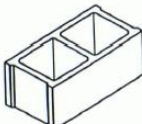
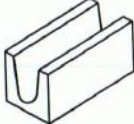
### BLOCCHI FACCIA VISTA

Immagine	Codice	Tipo	Misura cm	Dimensioni mm			REI	EI	MPa	N. per pacco	Peso Kg
				S	H	L					
<b>Lunghezza cm. 40</b>											
	BP1200	Forato	8x20x40	75	195	395			> 3,5	142	10
	BP1210	Forato	12x20x40	115	195	395			> 3,5	123	13
	BP1220	Forato	15x20x40	145	195	395			> 3,5	95	14
	BP1230	Forato	20x20x40	195	195	395			> 3,5	75	17
	BP1240	Forato	25x20x40	245	195	395				56	22
	BP1500	Correa	20x20x40	195	195	395				60	14

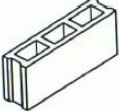
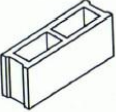
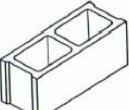
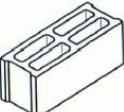

**A. Zambetti Srl**  
manufatti in cemento

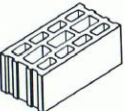
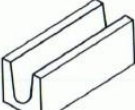
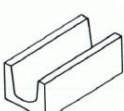
Lunghezza cm. 50											
	BP1205	Forato	8x20x50	75	195	495	45		> 3,5	120	11
	BP1215	Forato	12x20x50	115	195	495	60		> 3,5	96	14
	BP1217						90		> 3,5	96	14
	BP1219							120	> 3,5	96	14
	BP1250	Forato	15x20x50	145	195	495	60		> 3,5	72	15
	BP1260	Forato	20x20x50	195	195	495	120		> 3,5	60	20
	BP1270	Semiportante	20x20x50	195	195	495	180		> 3,5	60	24
	BF2550	Forato	25x20x50	245	195	495	120		> 3,5	48	25
	BF2560	Semiportante	25x20x50	245	195	495	120		> 3,5	48	29
	BP1510	Correa	20x20x50	195	195	495				60	25
	BP1520	Correa	25x20x50	245	195	495				40	25

I blocchi possono essere forniti anche colorati e/o impermeabilizzati

**RE/EI** = Certificato di resistenza al fuoco

**MPa** = Resistenza media a compressione